

DIGITAL CAMERA

ORCA[®]-Flash4.0

Changing the Game

Hamamatsu's brilliantly designed ORCA-Flash4.0 is truly a game changer in the world of scientific imaging. Built on a revolutionary new Gen II sCMOS detector, the ORCA-Flash4.0 is the first sCMOS camera that challenges the performance of all CCD, EM-CCD, and Gen I sCMOS cameras. With its combination of low noise and high quantum efficiency, the ORCA-Flash4.0 delivers unprecedented sensitivity as well as high dynamic range, blazing fast speeds, large field of view, and excellent resolution—all at once. The new standard for sensitivity, speed, and resolution is here. We think you will enjoy the results.

Exceptional sensitivity

Over 70 % at 600 nm

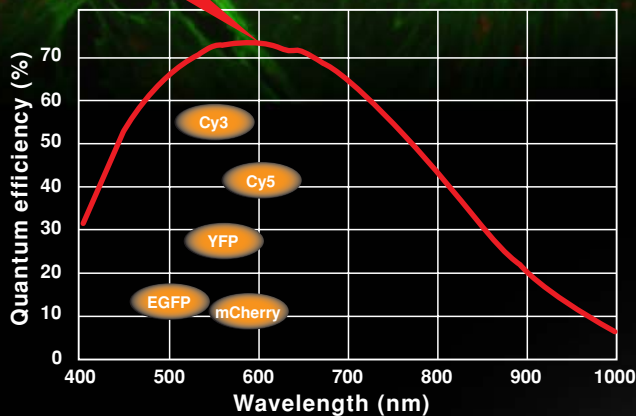

Low noise

1.3 electrons
at 100 frames/s

High-speed readout

100 frames/s
at full resolution

High resolution

4.0 megapixels
at $6.5 \mu\text{m} \times 6.5 \mu\text{m}$ pixels



HAMAMATSU
PHOTON IS OUR BUSINESS

High sensitivity means extreme versatility

Cooled CCDs have been the go-to technology for fluorescence applications such as GFP or multi-channel imaging that require high contrast, high signal-to-noise images. **The ORCA-Flash4.0 is changing the game.**

And until now, scientists have used EM-CCDs for low-light, often high-speed imaging such as TIRF or spinning disk confocal. For lack of a better choice, the same technology has also been adopted for localization microscopy. **Move over EM-CCD: the ORCA-Flash4.0 is changing this game, too.**

The performance of the ORCA-Flash4.0 camera offers such a multitude of benefits that it not only easily accomplishes each of these applications—it does them better.

Quantum efficiency: higher than 70 % at 600 nm and 50 % at 750 nm

The ORCA-Flash4.0 is engineered to outperform all other cameras for fluorescence microscopy. With carefully designed pixels and on-chip lens technology, its Gen II sCMOS sensor provides high QE across the range of wavelengths most commonly used in fluorescence microscopy.

Low noise: 1.3 electrons

The ORCA-Flash4.0 has the lowest read noise at 100 frames/s of any CCD or sCMOS camera. Even EM-CCDs trade off “relative” low read noise for multiplicative noise by using on-chip gain. But the ORCA-Flash4.0 requires no tradeoffs. Our “quiet” electronics successfully lower the limit of detection, allowing you to take full advantage of high frame rates and see your signal with fewer photons.

The unique combination of high quantum efficiency and low noise, in the absence of EM-CCD multiplicative noise, means that your images are not limited by the camera. Detect signal at low light levels, compare small changes in intensity, and discriminate small signals amid large backgrounds—with ease. **It's easy to see why the ORCA-Flash4.0 is changing the game.**

For detailed information on the effects of multiplicative noise in EM-CCDs compared to Gen II sCMOS sensors please review our white paper “ORCA-Flash4.0: Changing the Game” at <http://hamamatsucameras.com>

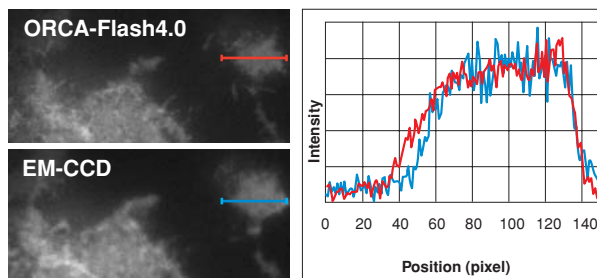

For the same number of input photons the ORCA-Flash4.0 delivers consistently higher signal-to-noise ratios compared to EM-CCDs. The large intensity variation apparent in the data from the EM-CCD is a direct result of multiplicative noise.

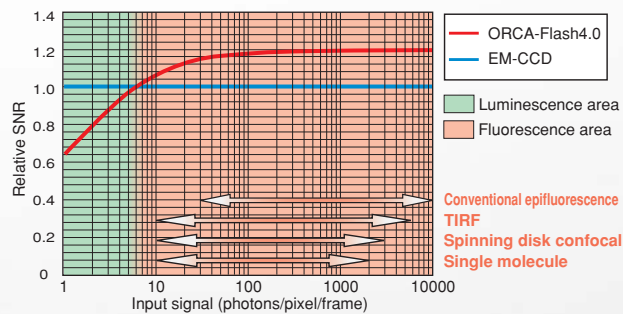
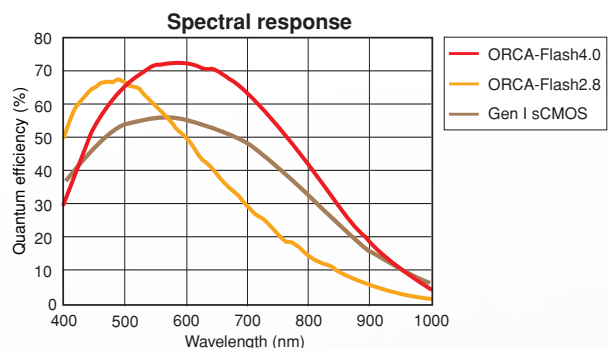

At just 5 photons per pixel, the ORCA-Flash4.0 exceeds the signal-to-noise performance of an EM-CCD camera.

Wide field of view & high resolution

With 4.0 megapixels at $6.5 \mu\text{m} \times 6.5 \mu\text{m}$ each, the ORCA-Flash4.0 is the ideal format for demanding microscopy applications. Whether imaging at high magnification, requiring finely detailed images of an individual cell, or low magnification, aiming to capture and resolve images of many cells, the ORCA-Flash4.0 delivers beautiful images.

■ Comparison of field of view

Field of view is 2.5× larger than that of a standard EM-CCD camera.

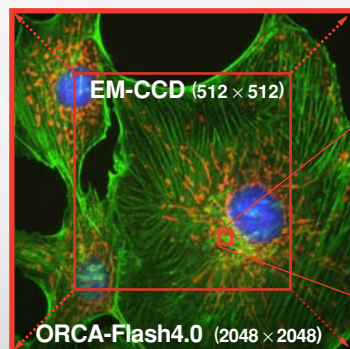

■ Comparison of resolution

The $6.5 \mu\text{m} \times 6.5 \mu\text{m}$ pixels of the ORCA-Flash4.0 enable much finer detail to be resolved when compared to the $16 \mu\text{m} \times 16 \mu\text{m}$ pixels of an EM-CCD camera.

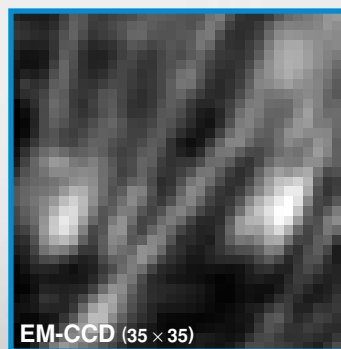
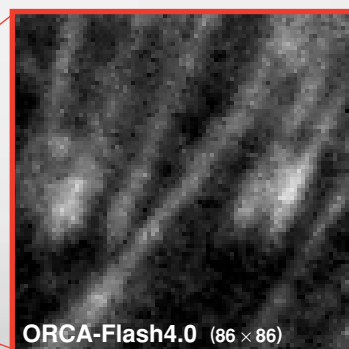

▲ Sample: FluoCells Prepared Slide #1, Object lens: S Plan Fluor 100×

High speed

Up to 15 min. of continuous full speed, full resolution acquisition*

4.0 megapixels, one hundred times per second—that is serious pixel throughput! Building on our experience with high-speed scanning cameras, Hamamatsu engineers designed the ORCA-Flash4.0 with dual CameraLink cables connected to a single, state of the art CameraLink board. When combined with a recommended solid state hard drive and high-speed computer, this configuration keeps your full resolution data flowing. For those experiments that need the most temporal resolution, the ORCA-Flash4.0 features flexible region of interest to dial up your speed—up to 25 656 frames/s.

Low noise and fast readout time simultaneously

Readout method	Number of pixels	Readout speed at center position (frames/s)
Full resolution	2048 × 2048	100
Sub-array readout (typical examples)	2048 × 1024	200
	2048 × 512	401
	2048 × 256	802
	2048 × 128	1603
	2048 × 64	3207
	2048 × 8	25 656

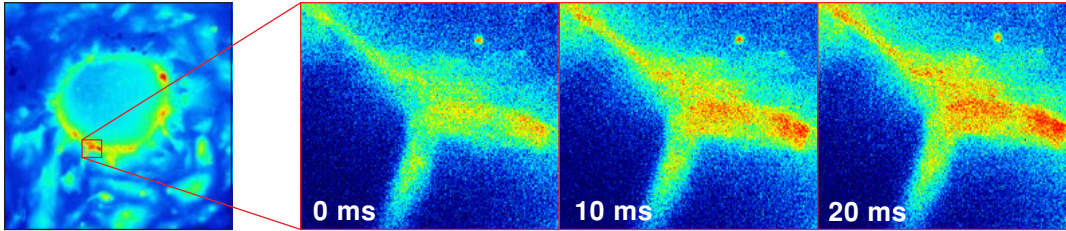

▲ High-speed Ca^{2+} imaging of cardiomyocyte derived from human iPS cell stained with Fluo8-AM. Sequential images were obtained every 10 ms. Left: whole FOV of the ORCA-Flash4.0 image. Right: magnified images show rapid and finely localized changes in intracellular Ca^{2+} concentration associated with cardiomyocyte contractions.

Behind-the-scene quality & innovations

The ORCA-Flash4.0 is a solid piece of camera engineering. Our small package bundles many years of Hamamatsu experience with an array of important and innovative performance enhancements.

Performance optimized cooling

For 25 years, Hamamatsu has been an industry leader in the cooling of scientific cameras. The ORCA-Flash4.0 is no exception. Air-cooled to $-10\text{ }^{\circ}\text{C}$, the ORCA-Flash4.0 finds the balance between meeting performance needs versus satisfying sleek marketing specs.

Outstanding image uniformity

At all input light levels the ORCA-Flash4.0 shows exceptional image uniformity across the entire sensor as compared to cameras based on Gen I sCMOS technology.

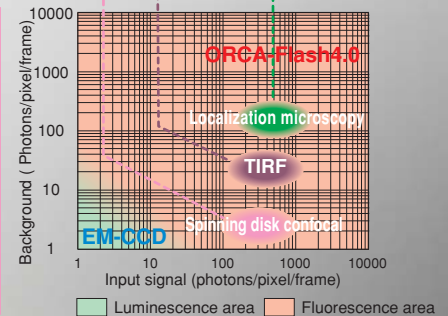
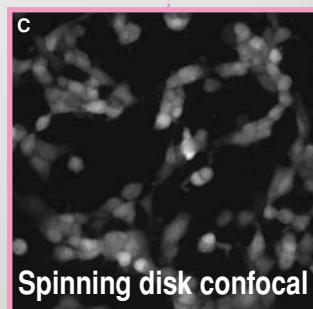
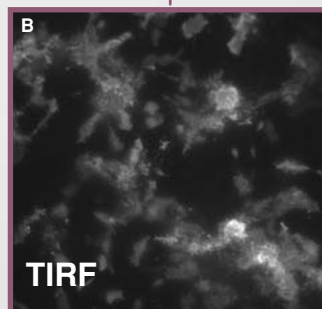
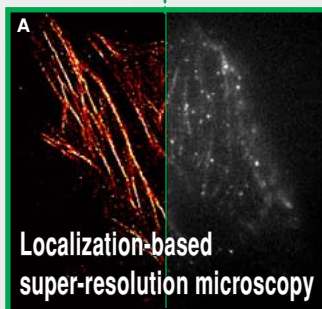
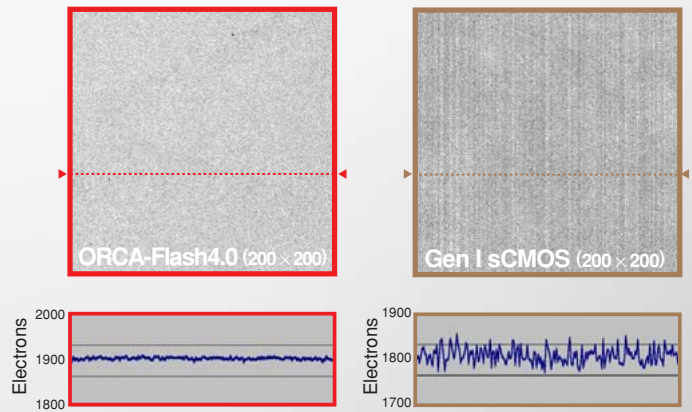

- A HeLa cells labeled with d2EosFP. Left: reconstructed image. Right: single TIRF image from data used for reconstruction. (Images courtesy of Prof. Zhen-li Huang, Britton Chance Center for Biomedical Photonics, Wuhan National Laboratory for Optoelectronics, Huazhong University of Science and Technology.)
 B Ins-1 cell MARCS-DsRed (Image courtesy of Dr. Hideo Mogami, Hamamatsu University.)
 C HEK293 cells stained with Fluo8-AM, Yokogawa CSU Spinning Disk Confocal



Specifications

Product number	C11440-22C (ORCA-Flash4.0)	
Imaging device	Scientific CMOS sensor FL-400	
Effective number of pixels	2048(H) × 2048(V)	
Cell size	6.5 μm × 6.5 μm	
Effective area	13.312 mm × 13.312 mm	
Full well capacity (typ.)	30 000 electrons	
Readout noise (at 100 frames/s, typ.)	1.3 electrons	
Dynamic range (typ.)	23 000:1	
Quantum efficiency	Higher than 70 % at 600 nm and 50 % at 750 nm	
Cooling method	Sensor temp.	Dark current (typ.)
Forced air (Ambient at +20 °C)	-10 °C	0.5 electrons/pixel/s
Water (+20 °C)	-20 °C	0.15 electrons/pixel/s
Water (+15 °C)	-30 °C	0.05 electrons/pixel/s
Readout speed		
Full resolution	100 frames/s	
1024 lines at center position	200 frames/s	
8 lines at center position	25 656 frames/s	
A/D conversion	16 bit output	
Readout modes	Digital binning 2 × 2 / 4 × 4 Sub-array readout mode	
Exposure time	9.7 μs to 10 s	
Digital interface	CameraLink full configuration Deca mode	
Lens mount	C-mount	
Power requirement	AC 100 V to AC 240 V, 50 Hz/60 Hz	
Power consumption	Approx. 90 VA	
Trigger in		
External trigger mode	Edge, Level, Synchronous readout and Start trigger	
External trigger signal routing	SMA connector or CameraLink I/F	
External trigger delay function	0 to 10 s in 10 μs steps	
Trigger out		
External signal output	3 programmable timing outputs Global exposure timing and Trigger ready output	
External signal output routing	SMA connector	
Software		
Software interface	PC-based acquisition package included DCAM-SDK, commercially available software	

Dimensional outlines

■ Camera head (approx. 2.0 kg)
Unit: mm

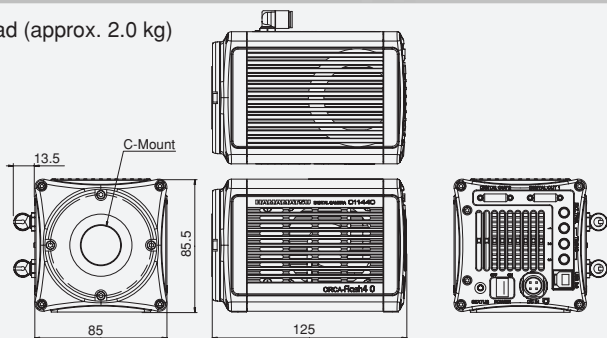

System configuration

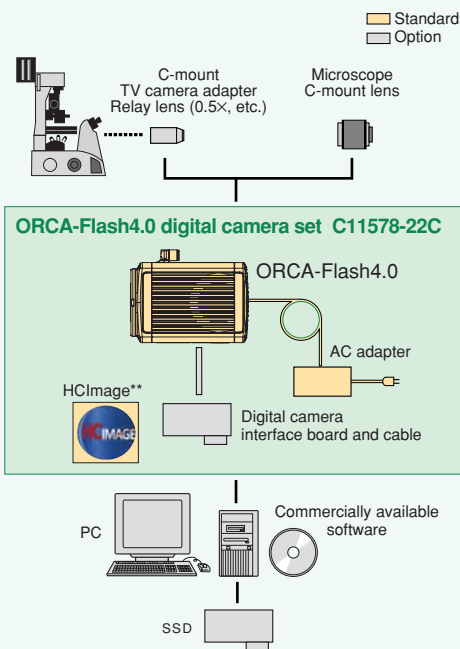

For details on microscope adapters and other optical blocks, please consult your local Hamamatsu sales representative.

Applications

The ORCA-Flash4.0 is ideally suited for fluorescence and other widefield microscopy applications.

- Super resolution microscopy
- TIRF microscopy
- Live cell GFP
- Time lapse fluorescence
- Ratio imaging
- FRET
- High-speed Ca²⁺ imaging
- Real-time confocal microscopy
- Light sheet microscopy
- Morphology
- Fluorescence in situ hybridization (FISH)

* This was tested with Dell T5500 (E5640 2.66GHz) + RAID 0 (LSI MegaRAID SAS 9260-8i) and 4 pcs SATA SSD drives (Crucial m4 SSD CT256M4SSD2) as of Jan 2012.
** HClmage software provides standard image measurements functions. Upgrades to more feature-rich versions are available.

ORCA is registered trademark of Hamamatsu Photonics K.K. (France, Germany, Japan, U.K., U.S.A.)

HClmage is registered trademark of Hamamatsu Photonics K.K. (Australia, China, EU, Japan, Norway, Singapore, Switzerland, U.S.A.)

Product and software package names noted in this documentation are trademarks or registered trademarks of their respective manufacturers.

• Subject to local technical requirements and regulations, availability of products included in this promotional material may vary. Please consult your local sales representative.

• Information furnished by HAMAMATSU is believed to be reliable. However, no responsibility is assumed for possible inaccuracies or omissions.

Specifications and external appearance are subject to change without notice.

© 2012 Hamamatsu Photonics K.K.

HAMAMATSU PHOTONICS K.K. www.hamamatsu.com

HAMAMATSU PHOTONICS K.K., Systems Division

812 Joko-cho, Higashi-ku, Hamamatsu City, 431-3196, Japan, Telephone

U.S.A.: Hamamatsu Corporation: 360 Foothill Road, P. O. Box 6910, Bridgewater, N.J. 08807-0910, U.

Germany: Hamamatsu Photonics Deutschland GmbH: Arzbergerstr. 10, D-82211 Herrsching am Amm

France: Hamamatsu Photonics France S.A.R.L.: 19, Rue du Saule Trapu, Parc du Moulin de Massy, 9

United Kingdom: Hamamatsu Photonics UK Limited: 2 Howard Court, 10 Tewin Road Welwyn Garden City I

North Europe: Hamamatsu Photonics Norden AB: Thorshamnsgatan 35 16440 kista, Sweden, Teleph

Italy: Hamamatsu Photonics Italia: S.R.L.: Strada della Moia, 1/E, 20020 Arese, (Milano), Italy, Teleph

China: HAMAMATSU PHOTONICS (CHINA) Co., Ltd.: 1201 Tower B, Jiaming Center, No.27 Dongsanhuan Bei



(주)엔아이텍
NEW INSTRUMENTS TECHNOLOGY

www.nitech.co.kr Tel. 02-6925-1048